



US Retail Price List
Krabat Jockey Family
2025



Account Information

Date	Account Number
Branch	Dealer Contact
Phone	Fax
Email Address	
PO Number	Mark For

Quote Order

Ship To Information

Name		
Address		
City	State	Zip
Phone		

Please complete this and return to Adaptive Imports by **fax** or **email**.

HiLo Base onfigurations



Jockey HiLo Base
Size 1 seat and Size 2 Seat options with low contoured, high contoured and Plus back options



It is a **Jockey** when *minimal* postural supports are used with a contoured back.

It is a **Jockey Plus** when postural supports such as laterals, chest straps, headrest, etc. are used with a planar style back.



US Retail Price List
Krabat Jockey Family



2025

Jockey

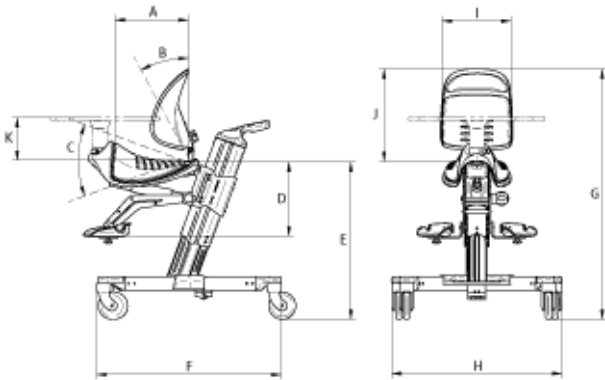

Age Range (approx)

	Size 1	Size 2
	2-6 yrs	6-14 yrs
A Seat Depth Max.	11 in.	13 in.
B Backrest Angle	90°	90°
C Tilt	-20°to +20°	-20 to +20°
D Distance Seat to Footrest	6 - 16 in.	10 - 20 in.
E Height of Seat	15 - 31 in.	15- 31 in.
F Total Length In Use / Folded	27 in. / 26 in.	39 in / 33 in.
G Total Height In Use / Folded	44 in. / 25 in.	48 in / 28 in.
H Total Width In Use / Folded	25 in. / 25 in.	26 in. / 26 in.
I Width of Backrest	10 in.	13 in.
J Height of Backrest	14 - 15 in.	16 - 17 in.
Chair Weight	27 lbs	33 lbs
Max User Weight	143 lbs	143 lbs

Jockey Plus

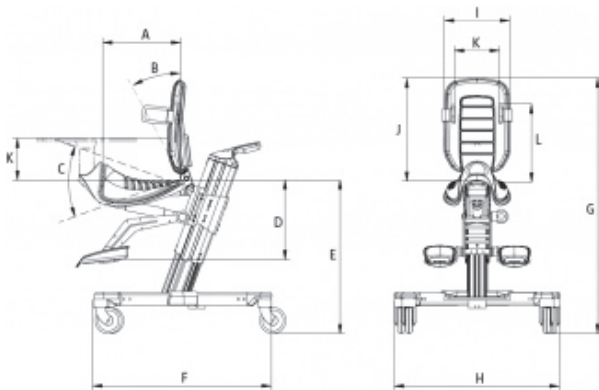

Age Range (approx)

	Size 1	Size 2
	2-6 yrs	6-14 yrs
A Seat Depth Max.	10 in.	13 in.
B Backrest Angle	90°	90°
C Tilt	-20°to +20°	-20 to +20°
D Distance Seat to Footrest	6 - 16 in.	10 - 20 in.
E Height of Seat	15 - 31 in.	15- 31 in.
F Total Length In Use / Folded	27 in. / 26 in.	39 in / 33 in.
G Total Height In Use / Folded	44 in. / 25 in.	48 in / 28 in.
H Total Width In Use / Folded	25 in. / 25 in.	26 in. / 26 in.
I Width of Backrest	10 in.	13 in.
J Height of Backrest	14 - 15 in.	16 - 17 in.
K Width of Side Supports	6 - 8 in.	8 - 10 in.
L Height of Side Supports	6 - 12 in.	9 - 15 in.
Chair Weight	27 lbs	35 lbs
Maximum User Weight	143 lbs	143 lbs

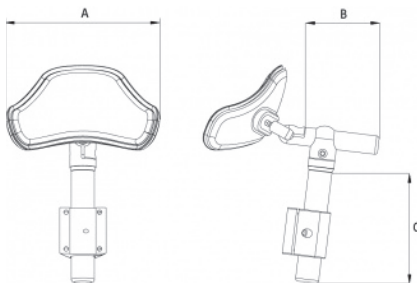



A Headrest Width	5 in.
B Depth Adj. Rod Length	3 in.
C Height Adj. Rod Length	5 in.



Complete Packages

Size 1

Size 2

<p>Jockey Complete Package</p>  <p>E1399</p> <p>Includes: Hi-Low base with gas spring height adjustment, 4 lockable casters, ergonomic saddle seat, ergonomic back (High or Low), hip belt, standard seat & back cover, individual footrests.</p> <p>**Tray Sold Separately</p> <p>JCKY1 Includes: 300-1001 Base, 900-1086 Seat Cushion (Sand), 900-1322 Size 1 Individual Footrest, 300-1104 Footrest Mount Hardware, 900-1174 Medium Hip Belt, 900-1153 Foam Seat Filling. <u>CHOOSE BACK BELOW:</u></p> <p>900-1134 Back Shell High Sz 1, 900-1185 Back Cushion (Sand) 900-1162 Back Shell Low Sz 1, 900-1164 Back Cushion (Sand)</p> <p>JCKY2 Includes: 300-4001 Base, 900-1091 Seat Cushion (Sand), 900-1193 Size 2 Individual Footrest, 300-1106 Footrest Mount Hardware, 900-1175 Large Hip Belt, Foam Seat Filling. <u>CHOOSE BACK BELOW:</u></p> <p>900-1135 Back Shell High Sz 2, 900-1179 Back Cushion (Sand) 900-1161 Back Shell Low Sz 2, 900-1169 Back Cushion (Sand)</p>	<p>JCKY1 <input type="checkbox"/> \$7,644</p> <p>High back 1 <input type="checkbox"/> N/C Low Back 1 <input type="checkbox"/> N/C</p>	<p>JCKY2 <input type="checkbox"/> \$7,862</p> <p>High Back 2 <input type="checkbox"/> N/C Low Back 2 <input type="checkbox"/> N/C</p>
<p>Jockey Plus Complete Package</p>  <p>E1399</p> <p>Includes: Hi-low base with gas spring height adjustment, 4 lockable casters, ergonomic saddle seat, plus backrest with laterals supports and mounting hardware, headrest and mounting bracket, hip belt, medium H strap, standard seat & plus back cover, individual footrests.</p> <p>**Tray Sold Separately</p> <p>JCKYPLS1 Includes: 300-1001 Base, 900-1086 Seat Cushion (Sand), 900-1236 Back Shell w/ Laterals 1, 900-1076 Back Cushion (Sand), 900-1322 Size 1 Individual Footrest, 300-1104 Footrest Mount Hardware, 900-1174 Medium Hip Belt, 900-1219 Headrest, 900-1215 H Chest Strap Small, 900-1153 Foam Seat Filling</p> <p>JCKYPLS2 Includes: 300-4001 Base, 900-1091 Seat Cushion (Sand), 900-1237 Back Shell w Laterals 2, 900-1181 Back Cushion (Sand), 900-1193 Size 2 Individual Footrest, 300-1106 Footrest Mount Hardware, 900-1175 Large Hip Belt, 900-1219 Headrest, 900-1216 H Chest Strap Medium, 900-1151 Foam Seat Filling</p>	<p>JCKYPLS1 <input type="checkbox"/> \$8,984</p>	<p>JCKYPLS2 <input type="checkbox"/> \$9,202</p>







US Retail Price List
Krabat Jockey Family
2025





Build your own Jockey

Size 1

Size 2

<p>Jockey HiLow Base</p>		<p>Hi-Low base with gas spring height adjustment, 4 lockable casters, ergonomic saddle seat.</p>	<p>300-1001 <input type="checkbox"/> \$4,767</p>	<p>300-4001 <input type="checkbox"/> \$4,985</p>
<p>Jockey Footrest (One Selection Required)</p>		<p>Individual Footrests. Adjustable molded shoe cups with straps. Size matched to base.</p>	<p>900-1322 <input type="checkbox"/> \$732</p>	<p>900-1193 <input type="checkbox"/> \$732</p>



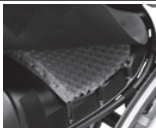

Back Options One Required

<p>Contoured Back Low</p>		<p>Shell Pad (Sand) *Required</p>	<p>900-1162 <input type="checkbox"/> \$840 900-1164 <input type="checkbox"/> \$380</p>	<p>900-1161 <input type="checkbox"/> \$840 900-1169 <input type="checkbox"/> \$380</p>
<p>Contoured Back High</p>		<p>Shell Pad (Sand) *Required</p>	<p>900-1134 <input type="checkbox"/> \$1,273 900-1185 <input type="checkbox"/> \$380</p>	<p>900-1135 <input type="checkbox"/> \$1,273 900-1179 <input type="checkbox"/> \$380</p>
<p>Plus back with Laterals</p> <p>Accessories</p>		<p>Shell Pad (Sand) *Required</p>	<p>900-1236 <input type="checkbox"/> \$1,781 900-1076 <input type="checkbox"/> \$384</p>	<p>900-1237 <input type="checkbox"/> \$1,781 900-1081 <input type="checkbox"/> \$494</p>

<p>Tray</p>		<p>Removable, height adjustable, Size matched to base.</p>	<p>900-1334 <input type="checkbox"/> \$655</p>	<p>900-1335 <input type="checkbox"/> \$785</p>
<p>Gel Seat Insert</p>		<p>Gel pad under seat upholstery for pressure relief. Size matched to base</p>	<p>900-1153 <input type="checkbox"/> \$353</p>	<p>900-1151 <input type="checkbox"/> \$353</p>





4 Point Lap Belt 	Plastic squeeze buckle	Medium	900-1174	<input type="checkbox"/>	\$139
		Large	900-1175	<input type="checkbox"/>	\$139
		X-Large	900-1370	<input type="checkbox"/>	\$231
Horizontal Chest Strap  <small>*Dealer installation required</small>	Neoprene with velcro closure	Small	900-1127	<input type="checkbox"/>	\$420
		Medium	900-1128	<input type="checkbox"/>	\$420
H Vest 	Padded with center closure buckle	Small	900-1215	<input type="checkbox"/>	\$420
		Medium	900-1216	<input type="checkbox"/>	\$420
Extended Lat. Pads w/ Sternum Strap  <small>**Plus back only</small>	Covers standard laterals on Plus back for wrap around support.	one size	300-1081	<input type="checkbox"/>	\$796
Ankle Cuffs (pair) 	Two point base attachment with velcro closure	Sz 1	900-1205	<input type="checkbox"/>	\$462
		Sz 2	900-1206	<input type="checkbox"/>	\$462
Headrest 	Anatomic headrest pad with mounting hardware. One Size		900-1219	<input type="checkbox"/>	\$920
User Support Handle 	Front mounted, removable handle for user support. One size.		900-1337	<input type="checkbox"/>	\$357
Rear Push Handle 	Rear mounted handle for attendant pushing chair		300-3023	<input type="checkbox"/>	\$760

HEADALOFT

Additional External Head Support Option			
HeadAloft includes: -Adjustable, removable, padded headrest with (2) buckle attachment straps-3 different sized, flip-away head support straps -Occipital support cushion			
	HEADALOFT	\$490	<input type="checkbox"/>

